

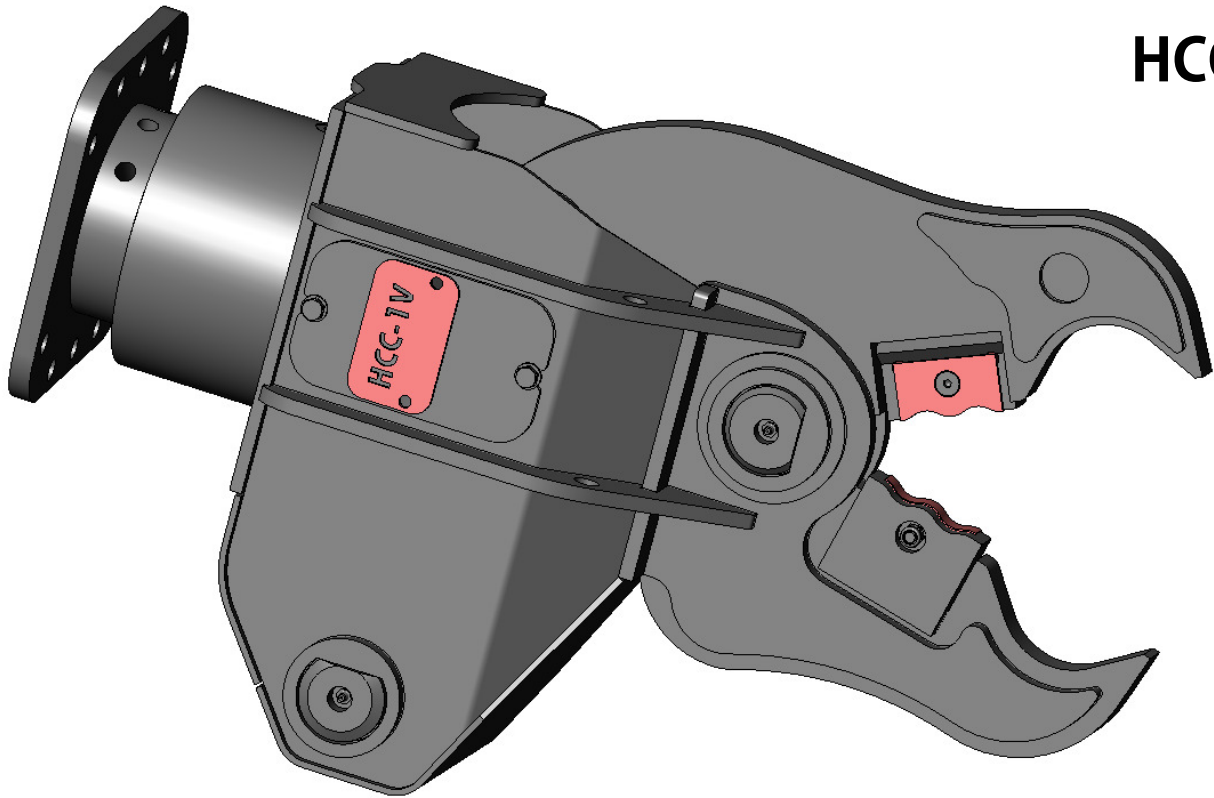











HCC SERIES

CRUSHERS BETONSCHEREN

HCC-1V



HCC-1V			
 (1)	Baggerklasse/Excavatorclass	T.	1,5-3,0
	Gewicht / Weight	Kg.	180
A	-	mm.	240
B	-	mm.	910
C	-	mm.	30
	Messerlänge / cutter length	mm.	84
X	-	T.	75
Y	-	T.	22
	Cylinder output/ Zylinder Kraft	T.	21
	Arbeitsdruck / Workingpressure	Bar	220
	Ölvolumenstrom / Oilflow	L/min.	20-25
	Drehbar / Rotatable		
	Arbeitsdruck beim rotieren / Workingpressure rotation	Bar	220
	Ölvolumenstrom beim rotieren / Oilflow rotation	L/min.	8
	Open/close (sec.) Öffnen/Schließen (sek.)		1,3-1,6

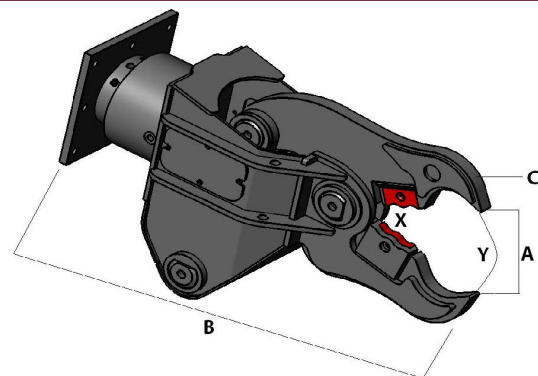

(**) The above mentioned weight is without connection plate
 (1) Recommended excavator / attachment combination
 equipped with 1 cylinder

(**) Die oben genannten Gewichte beinhalten nicht die Bagger Anbauplatte
 (1) Empfohlene Bagger/Anbauteil Kombination
 ausgestattet mit 1 Zylinder